

12 Watt — LT12W Series VER A0

CONSTANT CURRENT WITH TRIAC/ELV DIMMABLE LED DRIVER

High-Performance TRIAC dimmable LED driver

US & CN, LED Driver Class 2

LT series driver is a high-performance TRIAC dimmable LED driver that provides smooth, continuous <10% dimming for virtually any LED fixture. It is the most versatile LED driver offered today due to its compatibility with a wide variety of LED arrays, for almost all of trailing edge & leading edge AC dimmer.

Key Features

- Drive Mode: LT12W277 series
- Technology: Active PFC 1-Stage Switch Mode.
- Input Voltage: 220-277 VAC, 50/60Hz, no dimmer
277 VAC, 60Hz ,With 277V AC Dimmer
- Output Power: 12 Watt Max.
- AC Dimmer: Trailing Edge & Leading Edge AC Dimmer
- Dimming Range: Smooth & Continuous Dimming from 10% to 100%.
- Efficiency: Up to 84%.
- Warranty: 5 years.

Special Features

- Continuous dimming from 10% to 100%.
- Triac or phase cut dimming.
- Safety isolation between primary and secondary.
- A rated lifetime of 50,000 hours @ Tc = 80°C.
- Safety: UL8750, UL1310 Class 2, CSA22.2.
- EMC: FCC Part 15 Class A.
- Inrush Current Limiting Circuitry: AC Power Line: line to line 2 kV, eliminates circuit breaker tripping, switch arcing and relay failure.
- Plastic shell, Used with silicone potting.
- Meet the RoHs directive.
- IP66, NEMA4 compliant for Dry, Damp location.
- 100% performance tested with CHROMA 8000 system at YG factory.
- 100% burned in with program-control test system at YG factory, at 50 degrees ambient temperature.

12W Triac Dimming Part List

No.	Part Number	US Class 2	CN Class 2	Output Voltage Range	Output Constant Current Range	Current Accuracy	Power Factor	Output Power	Max. Eff.
1	LT12W277-48-C0250	Yes	Yes	32~48Vdc	25-250mA	±5%	0.90	12W	85%
2	LT12W277-43-C0280	Yes	Yes	28~43Vdc	28-280mA	±5%	0.90	12W	84%
3	LT12W277-36-C0350	Yes	Yes	24~36Vdc	35-350mA	±5%	0.90	12W	84%
4	LT12W277-28-C0430	Yes	Yes	18~28Vdc	43-430mA	±5%	0.90	12W	83%
5	LT12W277-24-C0500	Yes	Yes	16~24Vdc	50-500mA	±5%	0.90	12W	83%
6	LT12W277-20-C0600	Yes	Yes	13~20Vdc	60-600mA	±5%	0.90	12W	82%
7	LT12W277-17-C0700	Yes	Yes	11~17Vdc	70-700mA	±5%	0.90	12W	82%
8	LT12W277-12-C1000	Yes	Yes	8~12Vdc	100-1000mA	±5%	0.90	12W	80%



Enclosure



Size	Unit	Inch	Millimeter
	Case Length		3.36
Case Width		1.40	35.50
Case Height		0.90	23.00



Excellent LED Drivers

Sino-US joint venture

Input Specifications

Parameter	Min.	Typ.	Max.	Notes / Conditions
Input Voltage	198 Vac	---	305 Vac	220, 230, 277 Vac Nominal Values.
Input Frequency	47 Hz	50/60 Hz	53 Hz	50/60 Hz Nominal.
Input AC Current	---	---	0.06 A	Measured at 277 Vac / 50Hz Input, Output Full Load.
Inrush Current (Peak)	---	30 A	36 A	Measured at 277 Vac / 50Hz Input, Output Full Load.
Leakage Current	---	---	700 μ A	Measured at 277 Vac / 50Hz Input, Output Full Load.
THD	---	---	20%	Measured at 220, 230, 277 Vac Input, \geq 60% Load.
Power Factor (PF)	0.90	---	---	

Output Specifications

Parameter	Min.	Typ.	Max.	Notes / Conditions
DC Output Voltage	8V	---	48V	Measured at 220, 230, 277 Vac Input, The voltage is DC+ to DC-.
Output Power	---	---	12W	Measured at 220, 230, 277 Vac Input.
Flickering Index (Ipk-pk)	---	---	30%	20MHz BW, Full load output in parallel with 0.1 μ F & 10 μ F CAP. Flickering Index is defined as $[(I_{max}-I_{min})/(I_{max}+I_{min})] * 100\%$.
Line Regulation	-5%	---	+5%	Maximum over entire range of input voltage / output loads (any combination), and temperature range.
Load Regulation	-5%	---	+5%	
Turn-on Time	---	500 ms	1000 ms	From VAC turn-on until output current reaches 10% of nominal value. Output Full Load.
Turn-off Delay	---	---	1000 ms	LED's not lit, No die glow.
Output Overshoot	-5%	---	+10%	Measured at 220, 230, 277 Vac Input, When power on or off.

Protection Specifications

Parameter	Min.	Typ.	Max.	Notes / Conditions
Output Over Voltage (OVP)	---	---	60V	No Damage. Auto recovery when the leads are open.
Output Short Circuit (SCP)	---	---	---	No Damage. Auto recovery after short is removed.

Dimming Specifications

Items	Parameter	Min.	Typ.	Max.	Notes / Conditions
Phase cut Dimming	Turn-on Time	---	1000 ms	3000 ms	At 10% dim level. This time is AC input to the DC 10% output current. Less than 1000ms, for most dimmer.
	Flickering Index	---	---	30%	Flickering Index is defined as $[(I_{max}-I_{min})/(I_{max}+I_{min})] * 100\%$.
	Output Current Range	10%	---	100%	CCR output.
	Shimmer	---	---	7%	Long Term Current Stability (Average can't vary by more than X% over 10s period).
	Dimming Curve Type			Similar to Log	Dim curve between max/min.
	Acoustic Noise	---	---	22 dB	Not to exceed at 1 ft at any dim level.

General Specifications

Parameter	Min.	Typ.	Max.	Notes / Conditions
Cooling	Convection			
MTBF	680,000 hours			Measured at 277 Vac input, 100% Load and Tc=80° C (MIL-HDBK-217F).
Life Time	50,000 hours			

Environmental Specifications

Parameter	Min.	Typ.	Max.	Notes / Conditions
Case Temperature (T _c)	-30 °C	---	+90 °C	Measured at location specified on case.
Operating Temperature (T _a)	-30 °C	---	+55 °C	This is a reference range. T _c controls temperature range.
Storage Temperature (T _s)	-40 °C	---	+90 °C	Non operating temperature range.
Operating Humidity	---	---	95% RH	Relative Humidity. Non-condensing.
Vibration	5 Hz	---	55 Hz	1G, 10 minutes / 1 cycle, period 30 minutes, each along X, Y, Z axis.

Safety Compliance

Safety Category	Standards / Notes
UL / cUL	UL8750, UL1310 Class 2, CSA22.2.
Withstand Voltage	Input to Output: 2000 Vac.
Isolation Resistance	Input to Output: >10MΩ, 500Vdc @ 25°C, 70% RH.

EMC Compliance

EMI Category	Standards
FCC	FCC 47CFR Part 15 Class A, ANSI C63.4: 2009.
EMS Category	Notes
IEEE Std C62.41.2™-2002	Surge Immunity Test: ANSI C62.41 0.5 μs 100 kHz Ring, 2kV/0.2kA, L-N, L-G, LN-G (10 strikes) 1.2/50μs 8/20μs Combination, 2kV/0.5kA, L-N, L-G, LN-G (10 strikes)

Note: the above test data are in the condition of 25 C ambient temperature, except for the marked temperature.

Typical Applications

LED Forward voltage: V_F = 3.0V~3.5V

■. Driver Phase Cut Dimming

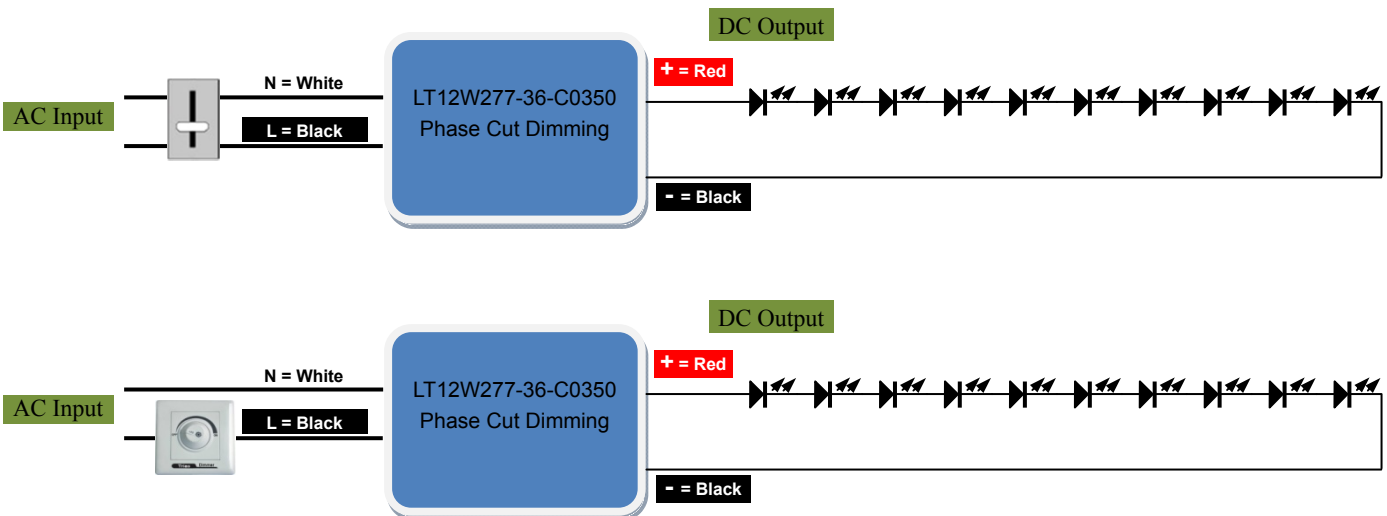

About Phase cut dimmer

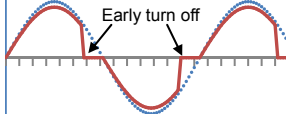
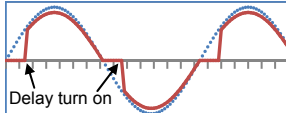
<p>ELV dimmer</p>	<ul style="list-style-type: none"> ▶ Electronic Low Voltage dimmer. ▶ Trailing Edge phase dimmer. ▶ Reverse phase control dimming. 		<p>Reverse phase be cut</p>	<ul style="list-style-type: none"> ▶ high stability. ▶ low noise. ▶ highest cost.
<p>TRIAC dimmer</p>	<ul style="list-style-type: none"> ▶ Incandescent phase dimmer. ▶ Leading Edge phase dimmer. ▶ SCR phase dimmer. ▶ Forward phase control dimming. 		<p>Forward phase be cut</p>	<ul style="list-style-type: none"> ▶ little worse stable. ▶ a little noise. ▶ lowest cost.

Dimming Curve

Typical Dimming vs. Turn-on Phase angle of AC Input at 25°C Ambient Temp

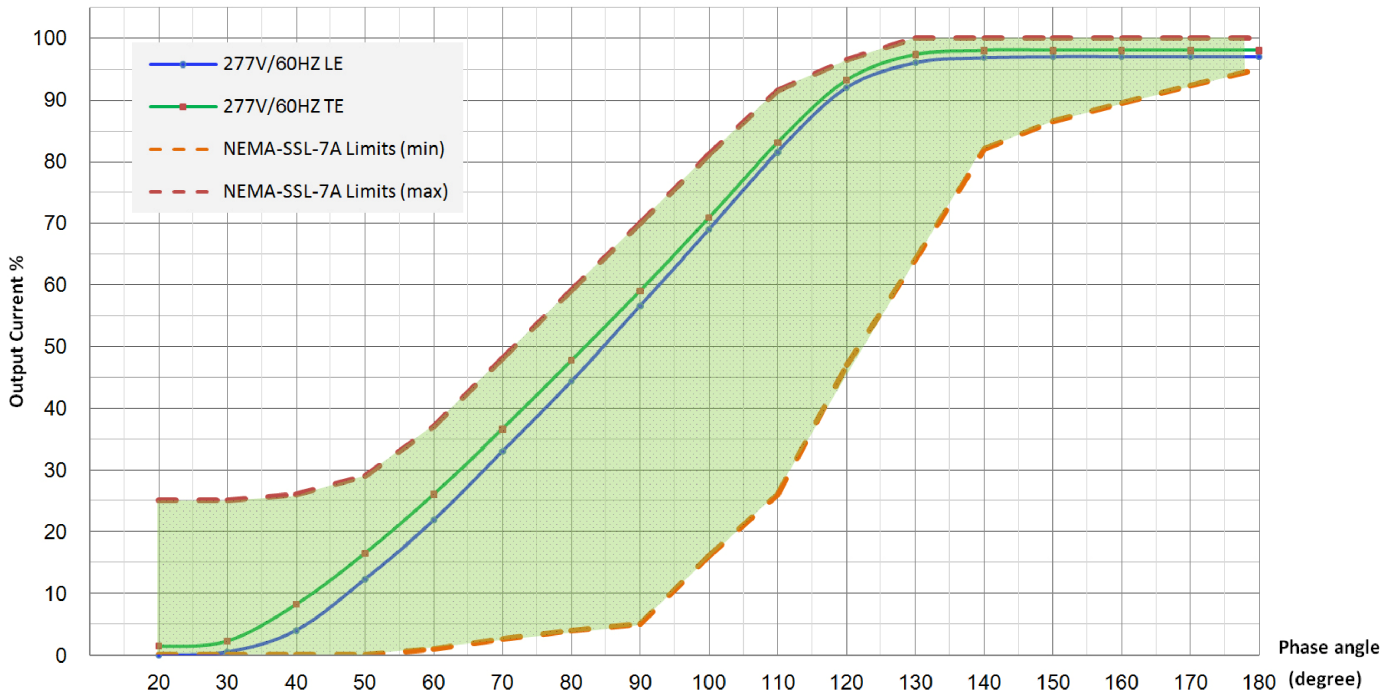

Characteristic Curve

Typical Efficiency vs. Pout at 25°C Ambient Temp

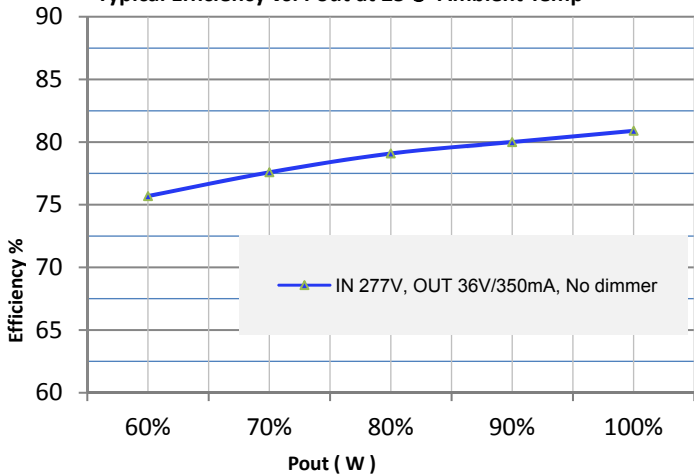

Typical PF vs. Pout at 25°C Ambient Temp

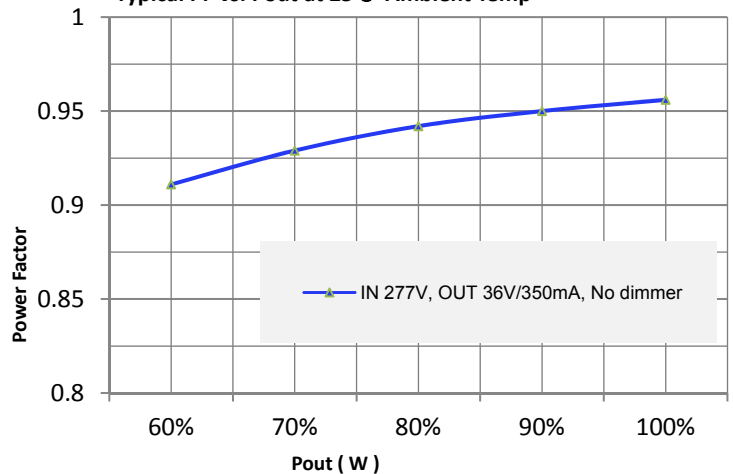

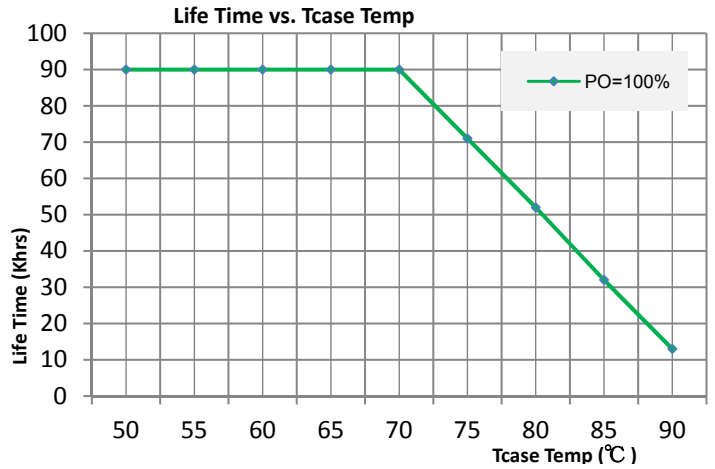
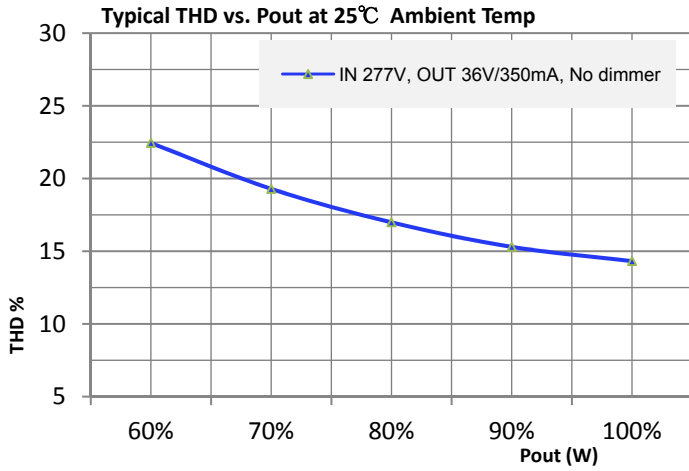

Installation

Plastic shell. This product has two $\Phi 3.5\text{mm}$ mounting holes.

AC input for connection the two core ANSI/UL1015/AWG18 temperature 105 °C core copper wire connection.

Cable Length: 150mm, stripping on the tin: 10mm.

Where: L — Black wire, N — White wire.

DC output for connection the two core ANSI/UL1569/AWG18 temperature 105 °C core copper wire.

Cable Length: 150mm, stripping on the tin: 10mm.

Where: DC+ — Red, DC- — Black.

Order ID

P/N : LT12W277-36-C0350

Description: 12W, 36Vdc voltage max, constant current 350mA, phase cut dimming mode.

Product Size

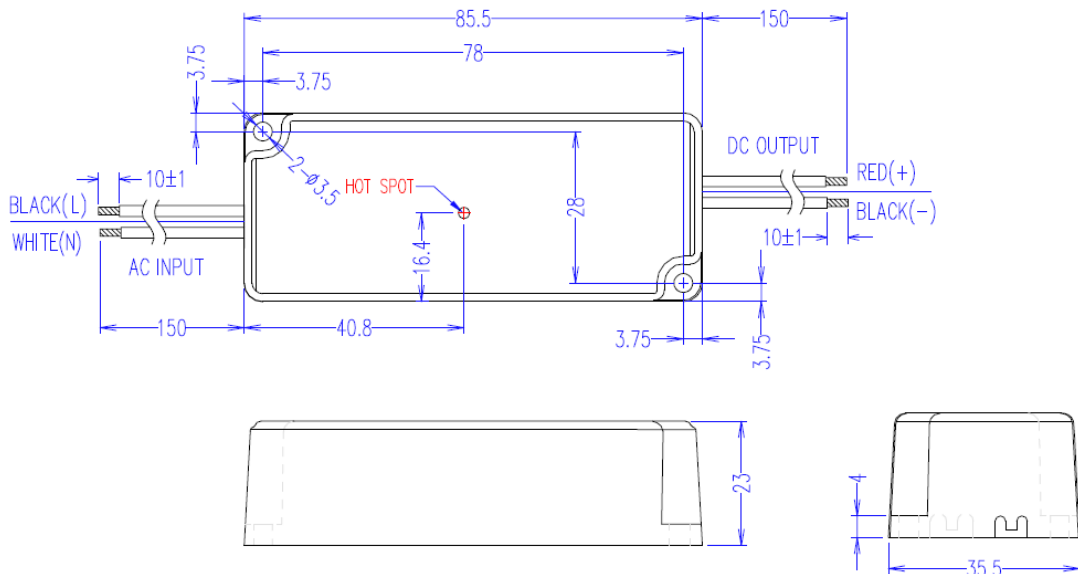

Application note

Picture 1

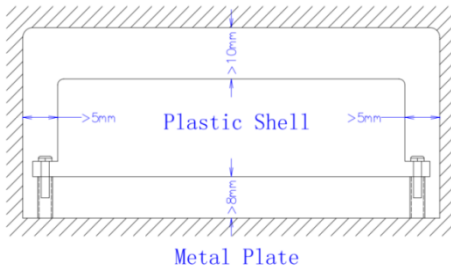

Picture 2

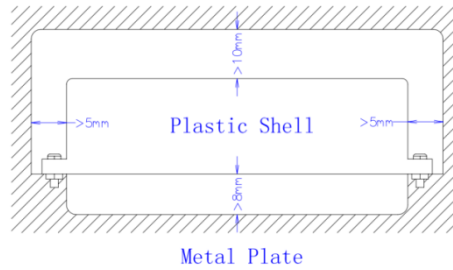

In Picture 1 and Picture 2,
EMC has the best.

Note :

- The independent LED drive conforms to the EMC standard.
But it is not guaranteed to be qualified, when the drive is mounted in the LED lamp.
- Please forgive us for any discrepancy due to the update of the specifications or the upgrade of the product.
If you need the latest information, please contact our marketing department.